

Description : Flat Lithium Battery
Chemical system : Lithium Manganese
Nominal voltage : 3 Volts
Nominal capacity : 40mAh
Dimensions : $\varnothing 12.5\text{mm} \times 2.0\text{mm}$
Shelf life : 5 years at room temperature
Average weight : 0.8 grams
Operation temperature: $-20^{\circ}\text{C} \sim 60^{\circ}\text{C}$
Storage temperature: $20^{\circ}\text{C} \pm 2^{\circ}\text{C}$

Cross References:

IEC	JIS	Panasonic	Varta
CR1220	CR1220	CR1220	CR1220

Discharge Characteristics

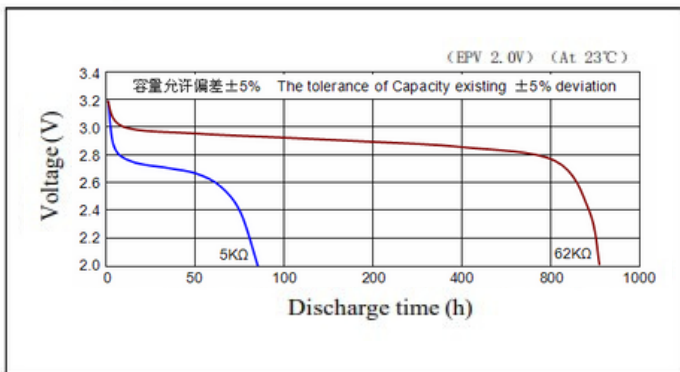

Model no.: **CR1220**

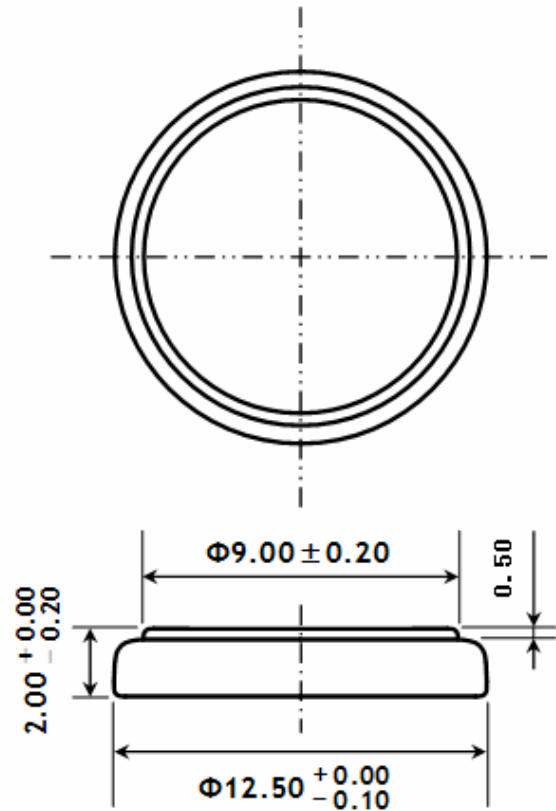

The information (subject to change without prior notice) contained in this document is for reference only and should not be used as a basis for product guarantee or warranty. For applications other than those described here, please consult your nearest GP Sales and Marketing Office or Distributors.